

SMART

tide



The Smart Tide is the perfect travel companion for your next trip! The double walled vacuum insulated travel bottle will keep water cold for up to 24 hours and hot drinks hot for up to 18 hours. Combining the convenience of a plastic bottle with the high efficiency and eco-friendly benefits of a traditional vacuum bottle. The Tide bottle is also suitable for juice drinks! The Tide bottle is a versatile drinking bottle with a generous 500ml capacity that will keep you hydrated on the go!

*Please note: These product images are used for illustration purposes only and the colours of the final product may vary slightly.

Features

- ✔ Designed with an airtight and leak-proof lid to prevent any unwanted spills
- ✔ Suitable for your favourite drinks, from Coffee to ice cold water
- ✔ Ideal for offices, schools, travelling and outdoor activities
- ✔ Premium Stainless Steel
- ✔ Lead Time: 2-3 Weeks
- ✔ MOQ: 50 units

Product Size and Weight

Length: 270mm
Width: 67mm
Height: 67mm
Product Weight: 360g

Carton Specification

Size: 76 x 39 x 27cm
Quantity: 50 Unit
Weight: 18kg

Pantone Match Quantity

Match the brand colours with a pantone match quantity of 500.



Printing Area and Branding Options

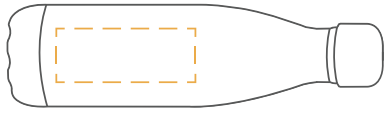

 **Engraved Print:**
100 x 45mm

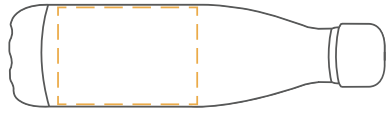

 **1-2 Spot Colour Print:**
100 x 70mm

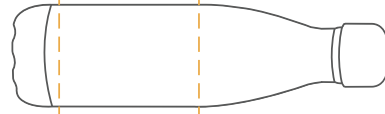

 **Full Colour Half Wrap Print:**
100 x 85mm

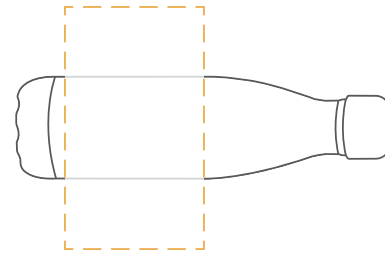

 **1 Spot Colour Wrap Print:**
170 x 100mm

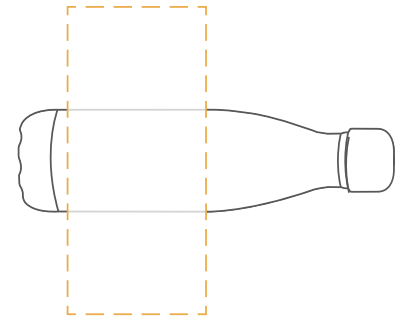

 **Full Colour Wrap Print:**
222 x 100mm



Print Options

1 Spot Colour 100 x 70mm



Standard UV Full Colour 100 x 30mm



Full Colour Half Wrap 100 x 85mm

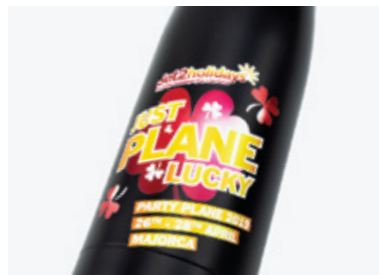

1 Spot Colour Wrap 180 x 100mm



Full Colour Wrap 222 x 100mm

